

# RJSPS1622A KeyLock Series



## Features

- Installation diameter: 16mm
- Degree of Protection: IP65
- Silver Plated of contact: 3 μ
- Compact design saves space
- Shade UV
- Super bright LED cold light source lamp display

## LED Ratings

Rated Voltage	Current
5V DC ± 5%	8mA
6V AC/DC (± 10%)	AC: A, R, W, Y: 8mA G, S: 7mA
	DC: A, R, W, Y: 6mA G, S: 5mA
12V AC/DC (± 10%)	AC: 9mA DC: 8mA
24V AC/DC (± 10%)	AC: 9mA DC: 8mA

## How to order:

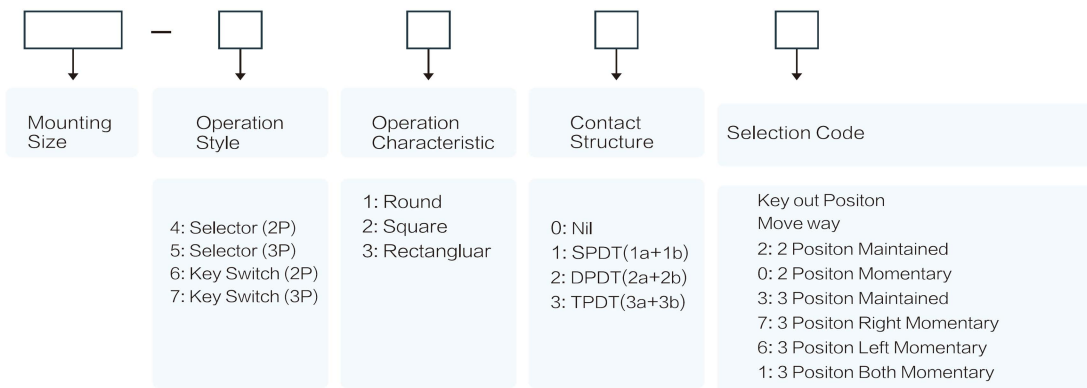

Sort	Reset Style				Key out Positon						
	Maintained	Momentary									
3Positon											
Code	2	0			A	B		D			
3Positon											
Code	3	7	6	1	A	B	C	D	E	F	G

Selector/Key basic rotation angle 90°

## Specifications













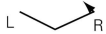
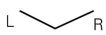

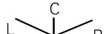
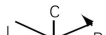
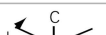
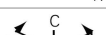
Degree of Protection	IP 65 Watertight /Oiltight
Contact Configuration	Single Pole, Double Pole
Maximum Voltage	250V AC/DC
Thermal Current	5A
Minimum Applicable Load	5V AC/DC, 1mA
Contact Material	Gold-plated silver
Terminal Style	.110" Solder/Quick Connect
Operating Temperature	-25°Cto +55°C
Operating Humidity	45 to 85% RH
Contact Resistance	50MΩ maximum
Insulation Resistance	100MΩ minimum (500V DC megger)
Vibration Resistance	10 to 55Hz, amplitude 1.2mm p-p
Degree of Protection	>10g
Electrical Life	100,000 operations minimum (at full rated load)
Mechanical Life	Maintained: 1,000,000 operations minimum Momentary: 1,000,000 operations minimum Selector /Keylock: 250, 000 operations minimum
Dielectric Strength	Switch Unit: 2,000V AC, 1min. between live/dead part and terminals of different poles; 1,000V AC, 1 minute between terminals of the same pole; 1,500V AC, 1 minute between contact and lamp terminals. Illumination Unit: 2,000V AC, 1min. between live Part/ground
Soldering Temperature	20W/5 Seconds or 260C/3 seconds

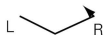
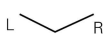
## Contact Ratings

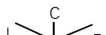
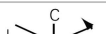
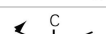
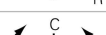
		Working voltage	24V	110V	220V
AC (50/60Hz)	Resistive	—	1.0A	0.5A	0.5A
	Inductive	—	0.7A	0.5A	0.5A
DC	Resistive	1.0A	0.2A	—	—
	Inductive	0.7A	0.1A	—	—

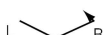
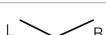
# RJSPS1622A KeyLock Series

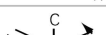
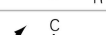
## KeyLock Switches

Product appearance	Operation		Contact	Model	
<p>Round</p>  <p>UL Recognized File No. E307512 CE CCC</p>	90° 2 2 Postion	 Maintained	SPDT	<b>RJSPS1622A Round -6112-G</b>	
		 Momentary	SPDT	<b>RJSPS1622A Round -6110-G</b>	
		 Maintained	DPDT	<b>RJSPS1622A Round -6122-G</b>	
		 Momentary	DPDT	<b>RJSPS1622A Round -6120-G</b>	
	90° 3 3 Postion	 Maintained	DPDT	<b>RJSPS1622A Round -7123-G</b>	
		 Left lock Right reset	DPDT	<b>RJSPS1622A Round -7127-G</b>	
		 Left reset Right lock	DPDT	<b>RJSPS1622A Round -7126-G</b>	
		 Momentary	DPDT	<b>RJSPS1622A Round -7121-G</b>	
	<p>Square</p>  <p>UL Recognized File No. E307512 CE CCC</p>	90° 2 2 Postion	 Maintained	SPDT	<b>RJSPS1622A Square -6212-G</b>
			 Momentary	SPDT	<b>RJSPS1622A Square -6210-G</b>
			 Maintained	DPDT	<b>RJSPS1622A Square -6222-G</b>
			 Momentary	DPDT	<b>RJSPS1622A Square -6220-G</b>
90° 3 3 Postion		 Maintained	DPDT	<b>RJSPS1622A Square -7223-G</b>	
		 Left lock Right reset	DPDT	<b>RJSPS1622A Square -7227-G</b>	
		 Left reset Right lock	DPDT	<b>RJSPS1622A Square -7226-G</b>	
		 Momentary	DPDT	<b>RJSPS1622A Square -7221-G</b>	
<p>Rectangle</p>  <p>UL Recognized File No. E307512 CE CCC</p>		90° 2 2 Postion	 Maintained	SPDT	<b>RJSPS1622A RECTANGULAR -6312-G</b>
			 Momentary	SPDT	<b>RJSPS1622A RECTANGULAR -6310-G</b>
			 Maintained	DPDT	<b>RJSPS1622A RECTANGULAR -6322-G</b>
			 Momentary	DPDT	<b>RJSPS1622A RECTANGULAR -6320-G</b>
	90° 3 3 Postion	 Maintained	DPDT	<b>RJSPS1622A RECTANGULAR -7323-G</b>	
		 Left lock Right reset	DPDT	<b>RJSPS1622A RECTANGULAR -7327-G</b>	
		 Left reset Right lock	DPDT	<b>RJSPS1622A RECTANGULAR -7326-G</b>	
		 Momentary	DPDT	<b>RJSPS1622A RECTANGULAR -7321-G</b>	

# RJSPS1622A KeyLock Series

## Selector and Key Switch Handle Positon

Operation					Contact	↙	↑	↗
90° 2 2 Positon	 Maintained		 Momentary		SPDT			
					DPDT			
90° 3 3 Positon	 Maintained	 Left lock Right reset	 Left reset Right lock	 Momentary	TPDT			

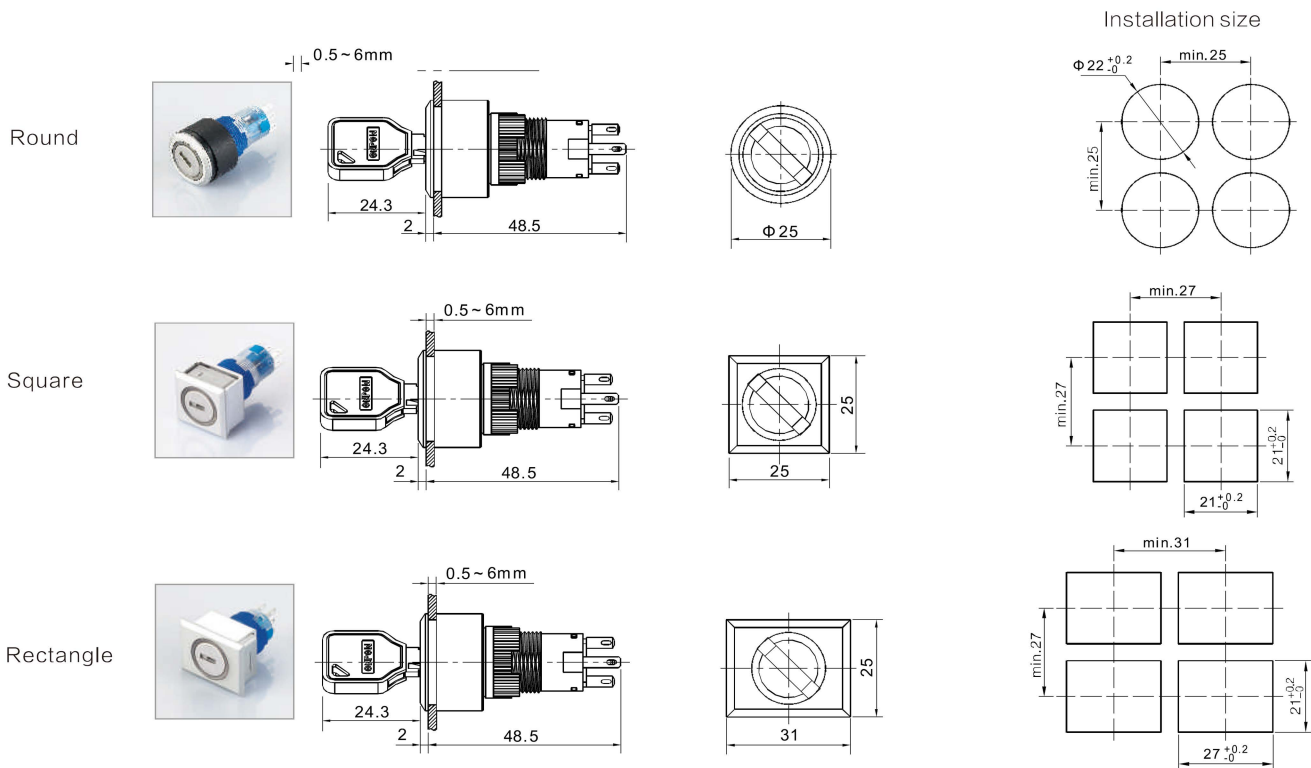

## Contacts circuit

