

RJSMS2225E Keylock Switches



Specifications

Operating Temperature	-20~+55°C		
Operating Humidity	45~85%		
Store Temperature	-45~+80°C		
Store Humidity	95%RH		
Degree of Protection	IP65(IEC 60529) IP20(IEC 60529)		
Insulation Resistance	100MΩ (500V DC)		
Dielectric Strength	2,500VAC/1		
	2,000VAC/1		
Vibration Resistance	10~500Hz	0.35mm	50m/s ²
	10~500Hz	0.35mm	50m/s ²
	5~55Hz 30Hz	0.5mm 1.5mm	
Shock resistance	150 m/s ²		
	1,000 m/s ²		
	100 m/s ²		
Mechanical Life	1,000,000		
	250,000		
	100,000		
Electrical Life	250,000		
	100 000		
	100,000		

Contact Ratings



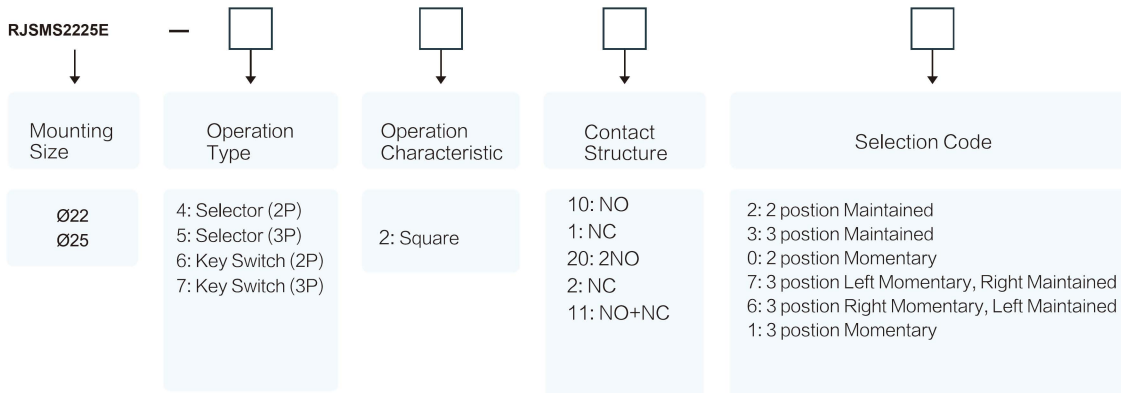

		600V			
		24V	120V	240V	380V
AC (50/60Hz)	Rated insulation voltage				
	Rated current	10A			
DC	Rated voltage	24V	120V	240V	380V
	(AC-12)	10A	10A	6A	2A
	(AC-15)	10A	6A	3A	1.9A
	(DC-12)	8A	2.2A	1.1A	-
	(DC-13)	4A	1.1A	0.55A	-

How to Order



RJSMS2225E Keylock Switches

Keylock Switch

Product appearance	Positions	Operation	Contact	Model
Key Switches 		Momentary	1NO	RJSMS2225E -6210-0
			1NC	RJSMS2225E -6201-0
			2NO	RJSMS2225E -6220-0
			2NC	RJSMS2225E -6202-0
			1NO+1NC	RJSMS2225E -6211-0
			1NO	RJSMS2225E -6210-2
		Maintained	1NC	RJSMS2225E -6201-2
			2NO	RJSMS2225E -6220-2
			2NC	RJSMS2225E -6202-2
			1NO+1NC	RJSMS2225E -6211-2
			2NO	RJSMS2225E -7220-3
			2NC	RJSMS2225E -7202-3
	Maintained	1NO+1NC	RJSMS2225E -7211-3	

Keylock Positions

/Sort	Reset Style				Key out Positon						
	Maintained	Momentary			A	B	C	D	E	F	G
3Positon											
Code	2	0			A	B		D			
3Positon											
Code	3	7	6	1	A	B	C	D	E	F	G

Selector/Key basic rotation angle 90°

Combination

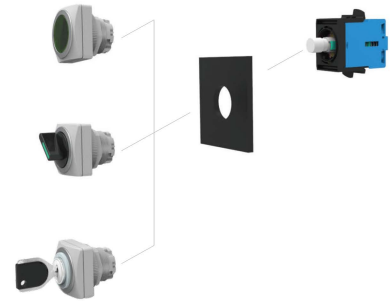

Drawing

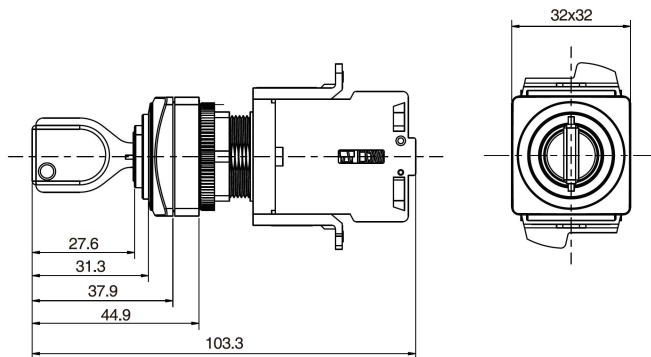

Panel Cut-out

