



Degree of Protection	IP67
Contact Type	1 NO
Rated Voltage	DC36V
Rated Current	2A
Minimum Applicable Load	3V AC/DC, 1mA
Contact material	Silver plated
Operating Temperature	-25° to +55°C
Operating Humidity	45 to 85% RH
Contact Resistance	≤50mΩ
Insulation Resistance	≤50mΩ
Vibration Resistance	10 to 55Hz, amplitude 1.2mm p-p
Degree of Protection	>10g
Electrical Life	200,000 operations minimum (at full rated load)
Mechanical Life	1,000,000 operations minimum
Dielectrical Life	Switch Unit: 2,000V AC, 1 min. between live/dead part and terminals of different poles; 1,000V AC, 1 minute between terminals of the same pole; 1,500V AC, 1 minute between contact and lamp terminals. Illumination Unit: 2,000V AC, 1 min. between live part/ground
Connection Form	Foot welding
Soldering Temperature	20W/5 seconds or 260°C/3 seconds
Tightening Torque	5-14N.m
Action Stroke	≤0.5mm
Action Force	≤3N



How to Order

RJS1N1LP - **67J**

12mm 16mm 19mm 22mm 25mm 30mm	Momentary	Flat	Ring Illuminated	LED Colour R Red G Green B Blue W White Y Yellow O Orange	Brushed Steel Black Anodised -Aluminium	Voltage 3V DC 5V/6.3V DC 12V DC 24V DC	IP Rating
--	-----------	------	------------------	--	---	---	-----------

FOR EXAMPLE: RJS1N1LP-25M-F-R-67J

*Wiring is available, Please contact us for more information.

Lamp Ratings

Lamp Type	LED lamp(DC)
Rated Voltage	3V,6V,12V,24V
Rated Current	Approx 15 - 20mA
LED Colour	R G Y O B W
Life	50000 hours(Reference)
Lamp Circuit diagram	
Power	0.06W
Chromogenic index	60-70
Luminous flux	80-100mcd(lm)
Forward voltage	2.0-3.2V
Reverse voltage	3V
(ESD) Electrostatic breakdown voltage	3000V
Rated current	0.006A
Lighting angle	120°
Luminous efficiency	110(lm/W)
thermal resistance	≤50°C/W
Maximum allowable junction temperature	120°C
Ageing time	1000 hours of conventional aging 100%; 6000 hours conventional aging 98%

Contact Diagram

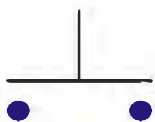

Contact Style

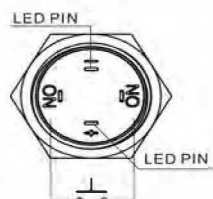

Terminal Description

Dimensions

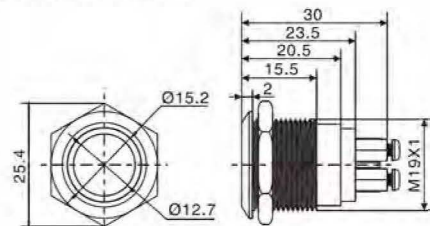

■ Non Illuminated Low Profile High Head Push Button

Appearance	Operation	Contact	Model	Voltage	Crust material
	Momentary	1NO	RJS1N1LP-12M-H~67J	24VDC 12VDC 6.3VDC 3VDC	Brushed Steel Black Anodised -Aluminium
		1NO	RJS1N1LP-16M-H~67J		
		1NO	RJS1N1LP-19M-H~67J		
		1NO	RJS1N1LP-22M-H~67J		
		1NO	RJS1N1LP-25M-H~67J		

■ Dimensions

RJS1N1LP-12M-H~67J

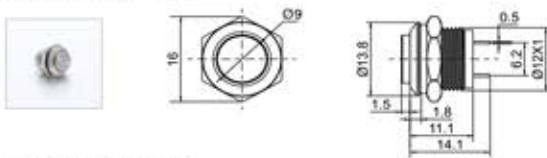

RJS1N1LP-16M-H~67J

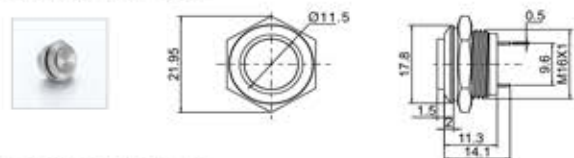

RJS1N1LP-19M-H~67J

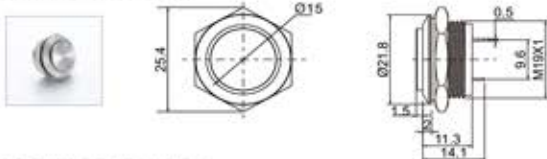

RJS1N1LP-22M-H~67J

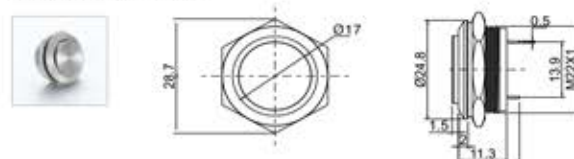



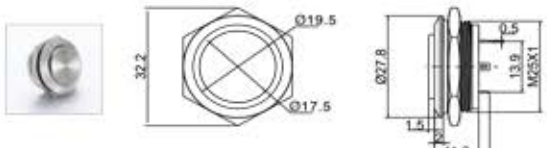



RJS1N1LP-25M-H~67J



- LED illuminated - High Head

High Head Low Profile Push Button Switches

Appearance	Operation	Contact	Model	Colour	Voltage	Crust material
	Momentary	1NO	RJS1N1LP-12M-H-R~67J	<ul style="list-style-type: none"> ■ Red ■ Green ■ Blue ■ White ■ Yellow ■ Orange 	24VDC 12VDC 6.3VDC 3VDC	Brushed Steel Black Anodised -Aluminium
		1NO	RJS1N1LP-16M-H-R~67J			
		1NO	RJS1N1LP-19M-H-R~67J			
		1NO	RJS1N1LP-22M-H-R~67J			
		1NO	RJS1N1LP-25M-H-R~67J			
		1NO	RJS1N1LP-30M-H-R~67J			

■ LED illuminated - High Head Dimensions

RJS1N1LP-12M-H-R~67J

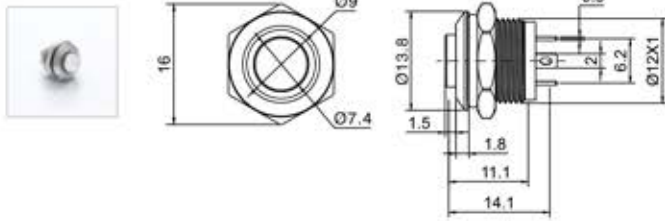

RJS1N1LP-16M-H-R~67J

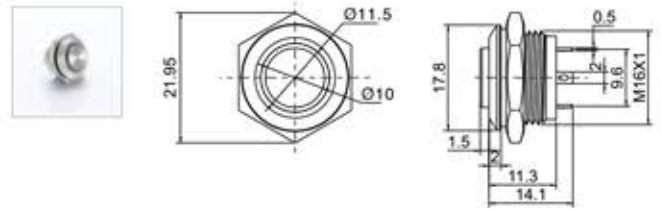

RJS1N1LP-19M-H-R~67J

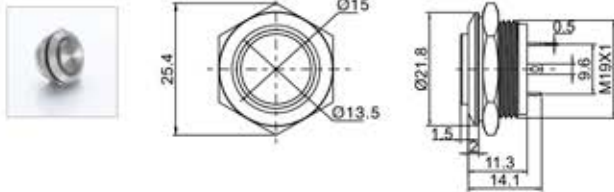

RJS1N1LP-22M-H-R~67J

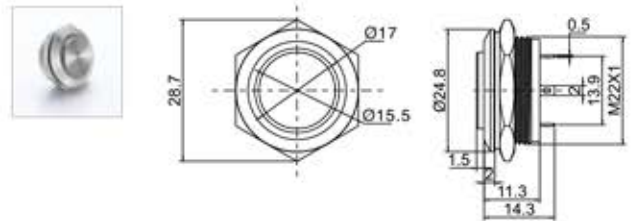

RJS1N1LP-25M-H-R~67J

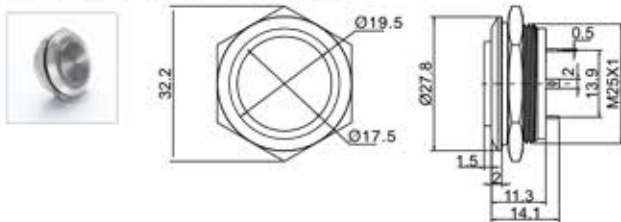

RJS1N1LP-30M-H-R~67J

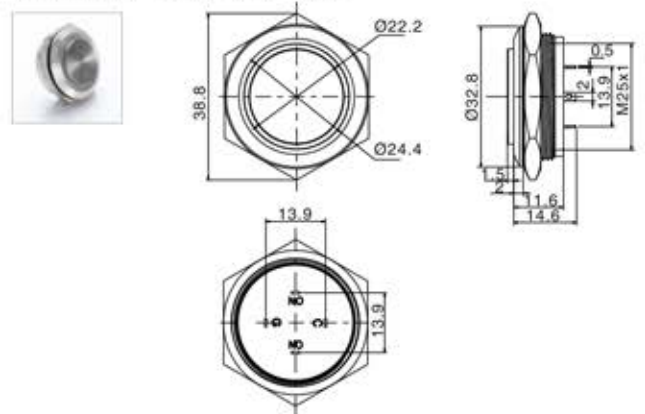

RJS1N1LP-30M-H-RGB~67J

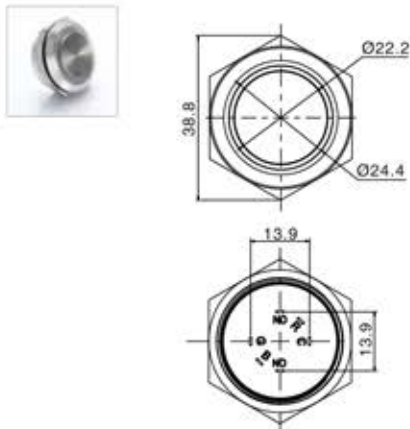

*Wiring is available, Please contact us for more information