

**RJS - K2 15mm, RJS-KA 12/15 mm SMT compatible Illuminating Switch**  
 Surface mounting (SMT) made possible in a world first for illuminating push-button switches



Maximum 70% reduction in installation costs! Improved installation quality!

- Surface-mountable terminals for fast, reliable.
- Pioneering manufacturing techniques prevent slanting and twisting during mounting, which improves counting accuracy and reduces corrections of bent switches and defects.
- Reduces the tilts and twists at the time of mounting by utilizing original know-how to dramatically improve mounting accuracy.  
 Also, there is no need for twist adjustments after mounting, so work efficiency will be increased drastically.
- Easy to assemble modular switch design features separate body and lighting section. Body is mounted to PCB and then assembled with the lighting section.
- Stable, consistent color and brightness.
- Ideal for switchers and command workstations.

■ **Features:**

- KA: 3 size and 3 shape button. Multicolor and Dual-Color LED are available.
- K2: 2 size and 3 Shape button. Dual-Color and Mono-Color LED are available.
- K9: 9mm square button only. Dual-Color and Mono-Color LED are available.

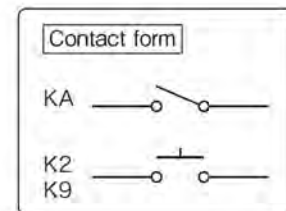

### Three Model Comparison

Model	KA			K2		K9
Button size	17.4mm square	15mm square	12mm square	15mm square	12mm square	9mm square
Button shape	Concave, Raise-Dot	Concave, Raise-Dot, Flat				Flat
Button structure	2 pcs ( Button and Color Plate)					1 pcs
Main body size	15×13×12mm			10.5×7.5×12mm		
Total length (including the button)	23mm					20mm
Total Travel (max)	4.0mm					2.0mm
Life	3 million times or more					300,000 times or more
Light color	Multicolor, Dual-Color			Dual-Color, Mono-Color		

## Specifications

Type	KA	K2	K9
Contact	Gold-Plated		
Electrical Rating	Maximum load: DC24V, 20 mA (resistance load)		
Insulation Resistance	More than 100 MΩ at 500V DC		
Dielectric Strength	Between terminals of the same pole: AC1000V Between terminals and the ground: AC1500V At 50/60 Hz, each for 60 sec. and normal temperature and humidity		
Contact Resistance	Less than 200 mΩ (Initial) at DC6V 0.05A	Less than 200mΩ (initial) at DC6V 0.1A	
Electrical life	More than 3 million operations at max. rated load		More than 3 hundred thousand operations at max. rated load
Mechanical life	More than 3 million operations		More than 3 hundred thousand operations
Ambient Temperature	-15°C ~ +50°C		
Ambient Humidity	85% RH (max.)		

## Operating Characteristics





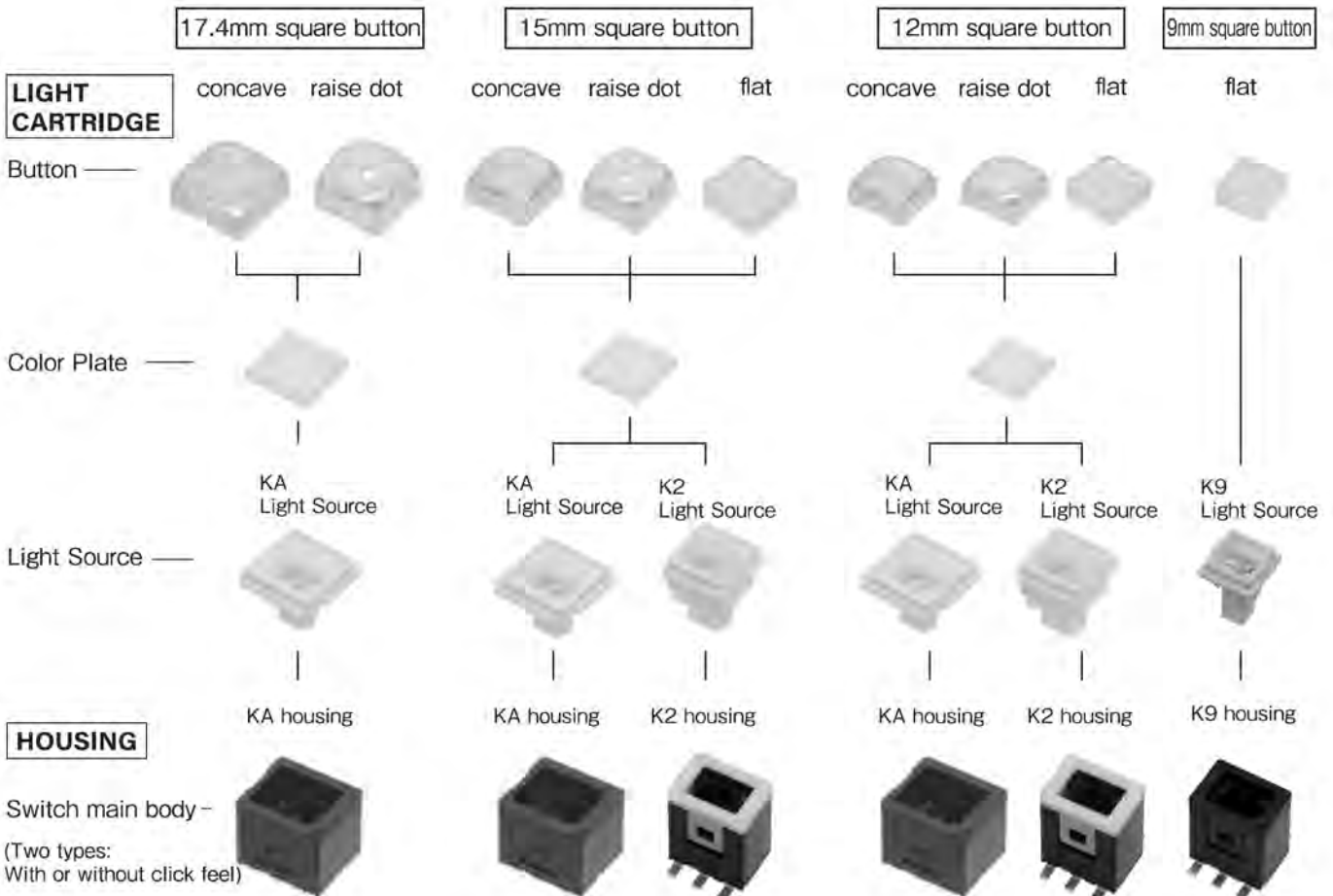

KA, K2	Operating Force (Max.)	2.0N	Total Travel (Max.)	4.0mm
K9	Operating Force (Max.)	2.0N	Total Travel (Max.)	2.0mm

## Structure

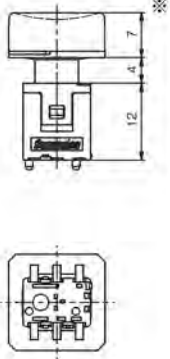
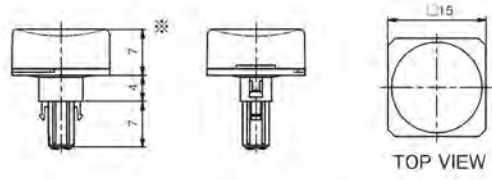

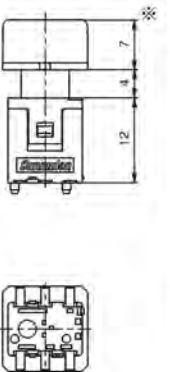
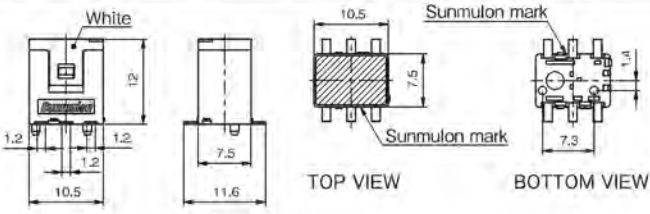
## ■ Dimensions

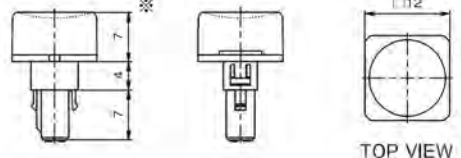
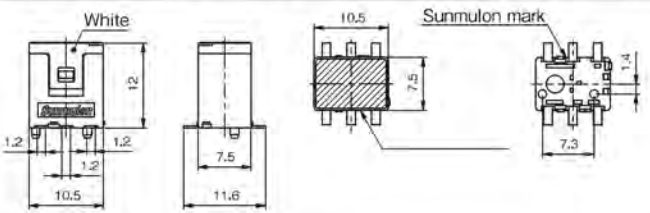
● K2 Housing is common to all the buttons.

<p style="writing-mode: vertical-rl; transform: rotate(180deg);">15mm square button</p> 		<p style="writing-mode: vertical-rl; transform: rotate(180deg);">LIGHT CARTRIDGE</p>  <p style="text-align: center;">TOP VIEW</p> <p>* The height of the button is the same for the raise dot button and the flat button.</p>
<p style="writing-mode: vertical-rl; transform: rotate(180deg);">12mm square button</p> 		<p style="writing-mode: vertical-rl; transform: rotate(180deg);">HOUSING</p>  <p style="text-align: center;">TOP VIEW      BOTTOM VIEW</p> <p>The hatched section  is covered with a heat-resistant sticker.</p> <p style="writing-mode: vertical-rl; transform: rotate(180deg);">LIGHT CARTRIDGE</p>  <p style="text-align: center;">TOP VIEW</p> <p>* The height of the button is the same for the raise dot button and the flat button.</p>
		<p style="writing-mode: vertical-rl; transform: rotate(180deg);">HOUSING</p>  <p style="text-align: center;">TOP VIEW      BOTTOM VIEW</p> <p>The hatched section  is covered with a heat-resistant sticker.</p>



## How to Order

### LIGHT CARTRIDGE

RJS-K2 - [ ] [ ] [ ] [ ] [ ]

● **BUTTON**

12	12 square
15	15 square

● **BUTTON SHAPE**

K	Concave button
P	Raise dot button
S	Flat button
※1) X	Without button

● **LED COLOR**

7	Red
8	Green
9	Yellow
78	Red and Green
718	Red and Super Green
X	Without LED

● **COLOR PLATE**

4	Milky white
※1) X	Without color plate

● **BUTTON COLOR**

C	Clear
※1) X	Without button

### HOUSING

K2 [ ] - K M

● **CIRCUIT CHARACTERISTIC AND OPERATIONAL FEEL ※2)**

S	Momentary, without click feel
M	Momentary, with click feel

● **TERMINAL**

M	Surface-mounted terminal
---	--------------------------

● **HOUSING COLOR**

K	Black
---	-------

#### Caution

- ※1) In case of selecting without button(X), without color plate(X), please order button and color plate separately.
- ※2) With or without click feel cannot be selected for the light cartridge. They can be selected for the housing only.

#### \*LED protection

For protecting LED, please apply suitable external current limiting resistors.

## Internal Connection Arrangement

### • KA

#### • Dual-color

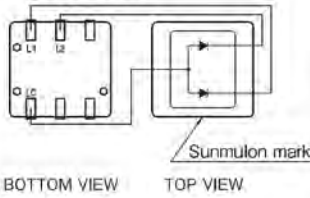

#### • Multicolor

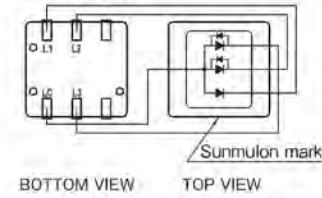

Terminals	LED color combination		
	Dual-color (78)	Dual-color (718)	Multicolor (22)
LC-L1	Red	Red	Red
LC-L2	Green	Super green	Super green
LC-L3			Super blue

### • K2

#### • Mono-color

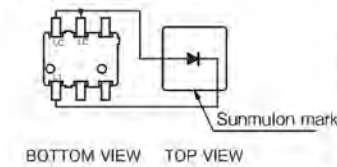

#### • Dual-color

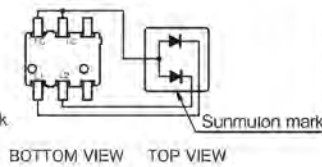

Terminals	LED color combination				
	Mono-color			Dual-color (78)	Dual-color (718)
LC-L1	Red	Green	Yellow	Red	Red
LC-L2				Green	Super green

### • K9

#### • Mono-color

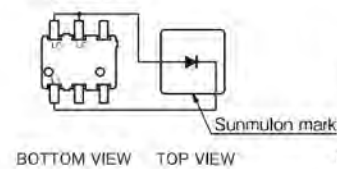

#### • Dual-color

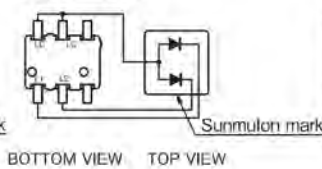

Terminals	LED color combination				
	Mono-color			Dual-color (78)	Dual-color (718)
LC-L1	Red	Green	Yellow	Red	Red
LC-L2				Green	Super green

## Terminal Layout

### • KA

#### • Dual-color

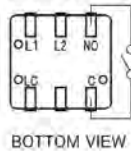

#### • Multicolor

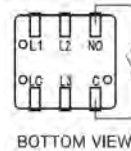

### • K2, K9

#### • Mono-color

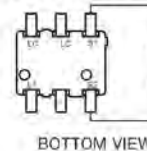

#### • Dual-color

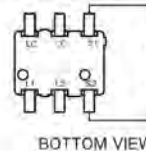

## Terminal Shape / PCB Layout

### • KA

#### • Terminal dimensions

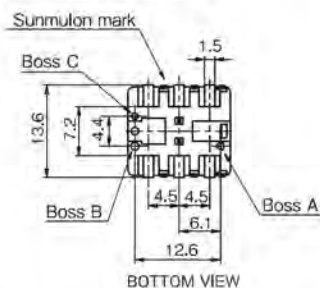

#### • Boss dimensions

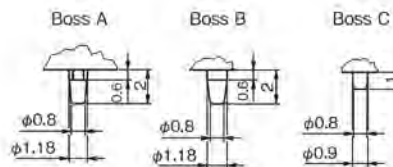

#### • Recommended PCB Layout

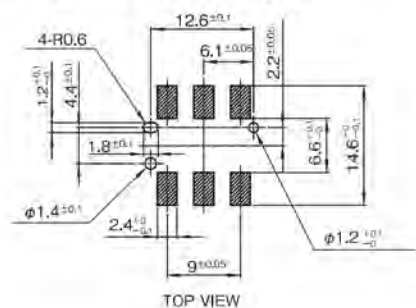

### • K2, K9

#### • Terminal dimensions

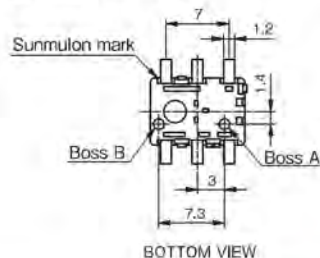

#### • Boss dimensions

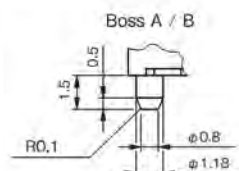

#### • Recommended PCB Layout

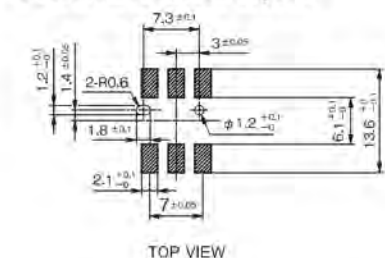



## LED Ratings / Protective Resistance

### KA

#### LED ratings

Item	Color	Full-face LED lighting (Ta=25°C)						
		Dual-color (78)		Dual-color (718)		Multicolor (22)		
		Red	Green	Red	Super green	Red	Super green	Super blue
Max. operating current I <sub>FM</sub> (mA)		25	20	20	10	50	35	25
Power Dissipation (mW)		60	48	48	38	127	124	88.7
DC reverse voltage V <sub>R</sub> (V)		5	10	5	5	5	—	—
Forward voltage V <sub>F</sub> (V) (standard values) ※		1.9	4.2	1.8	3.4	2.2	3.2	3.2
Dominant wavelength λ <sub>d</sub> ※		626	572	626	525	622	530	468
Forward current under the conditions of the above-mentioned ※ I <sub>F</sub> (mA)		20	20	10	10	20	20	20
Conditions when pulse is lit	Pulse width PW (μs)	400		400	15	10 <sup>4</sup>	10 <sup>4</sup>	10 <sup>4</sup>
	Duty ratio D <sub>R</sub>	10 <sup>-1</sup>		10 <sup>-1</sup>		10 <sup>-1</sup>		
	Allowable forward current for pulse I <sub>FP</sub> (mA)	92	92	50	150	110	80	
Wiring diagram		Figure 1				Figure 2		
Maximum Forward Current (including internal temperature)		Figure 3		Figure 4		Figure 5		

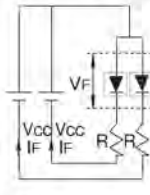

(Figure 1)

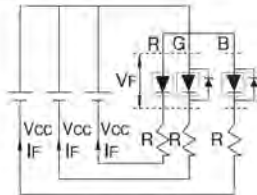

(Figure 2)

Refer to the following formula to calculate external resistance values.

$$R = \frac{V_{CC} - V_F}{I_F}$$

$V_F$  : LED forward voltage  
 $V_{CC}$  : Power supply voltage  
 $I_F$  : Recommended operating current

#### Maximum forward current – Ambient temperature

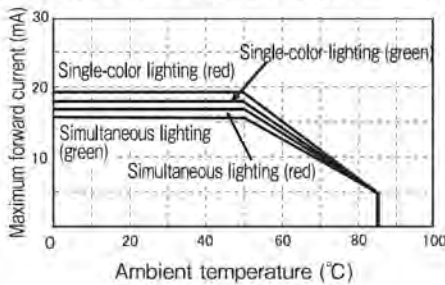

(Figure 3)

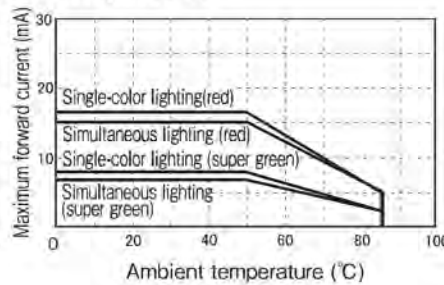

(Figure 4)

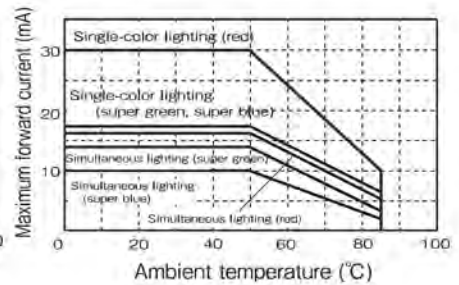

(Figure 5)

#### Reference external resistor

Ta=25°C

Button size	Color	Dual-color (78)		Dual-color (718)		Multicolor (22)		
		Red	Green	Red	Super green	Red	Super green	Super blue
KA 17.4 square	5V	390Ω 1/16W	56Ω 1/16W	300Ω 1/16W	510Ω 1/16W	1.5kΩ 1/16W	1.2kΩ 1/16W	1.8kΩ 1/16W
	12V	1.3kΩ 1/4W	510Ω 1/4W	1kΩ 1/4W	2kΩ 1/8W	4.7kΩ 1/16W	5.1kΩ 1/16W	6.8kΩ 1/16W
	24V	2.7kΩ 1/2W	1.3kΩ 1W	2.2kΩ 1/2W	4.7kΩ 1/4W	10kΩ 1/8W	12kΩ 1/8W	16kΩ 1/16W
	Reference operating current(mA)	8	15	10	5	2.2	1.8	1.4
KA 15 square	5V	510Ω 1/16W	91Ω 1/16W	360Ω 1/16W	620Ω 1/16W	1.6kΩ 1/16W	1.5kΩ 1/16W	2kΩ 1/16W
	12V	1.6kΩ 1/4W	820Ω 1/4W	1.2kΩ 1/4W	2.4kΩ 1/8W	5.1kΩ 1/16W	6.2kΩ 1/16W	8.2kΩ 1/16W
	24V	3.6kΩ 1/2W	2kΩ 1/2W	2.7kΩ 1/2W	5.6kΩ 1/4W	11kΩ 1/8W	15kΩ 1/16W	18kΩ 1/16W
	Reference operating current(mA)	6	10	8	4	2	1.4	1.2
KA 12 square	5V	620Ω 1/16W	130Ω 1/16W	510Ω 1/16W	910Ω 1/16W	2kΩ 1/16W	1.8kΩ 1/16W	2.4kΩ 1/16W
	12V	2kΩ 1/8W	1kΩ 1/4W	1.6kΩ 1/4W	3.6kΩ 1/16W	6.2kΩ 1/16W	8.2kΩ 1/16W	10kΩ 1/16W
	24V	4.3kΩ 1/4W	2.4kΩ 1/2W	3.6kΩ 1/2W	8.2kΩ 1/8W	13kΩ 1/8W	18kΩ 1/16W	22kΩ 1/16W
	Reference operating current(mA)	5	8	6	3	1.7	1.2	1



## LED Ratings / Protective Resistance

### ■ K2, K9

### ● LED ratings

Item	Color	Full-face LED lighting (Ta=25°C) □15, □12, □9						
		Mono-color			Dual-color (78) Figures in [ ] indicate □15		Dual-color (718)	
		Red	Green	Yellow	Red	Green	Red	Super green
Max. operating current I <sub>FM</sub> (mA)		25	20	25	25 (17) ※	20 (14) ※	20 (16) ※	10 (8) ※
Power Dissipation (mW)		60	48	60	60	48	48	38
DC reverse voltage V <sub>R</sub> (V)		5	5	5	5	5 [10]	5	5
Forward voltage V <sub>F</sub> (V) (standard values) ※		1.9	2.1	1.9	1.9	2.1 [4.2]	1.8	3.4
Dominant wavelength λ <sub>d</sub> ※		626	572	595	626	572	626	525
Forward current under the conditions of the above-mentioned ※ I <sub>F</sub> (mA)		20	20	20	20	20	10	10
Conditions when pulse is lit	Pulse width P <sub>W</sub> (μs)	400			400		400	15
	Duty ratio D <sub>R</sub>	10 <sup>-1</sup>			10 <sup>-1</sup>		10 <sup>-1</sup>	
	Allowable forward current for pulse I <sub>FP</sub> (mA)	92			92		92	50
Wiring diagram		Figure 6			Figure 7			
Maximum Forward Current (including internal temperature)		Figure 8			Figure 9		Figure 10	

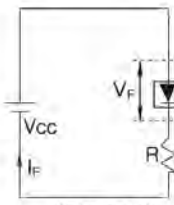

(Figure 6)

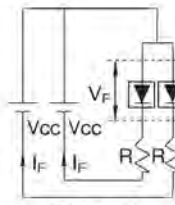

(Figure 7)

※ In case of Simultaneous lighting, please follow the figures in ( ),

Refer to the following formula to calculate external resistance values.

$$R = \frac{V_{CC} - V_F}{I_F}$$

$V_F$  : LED forward voltage  
 $V_{CC}$  : Power supply voltage  
 $I_F$  : Recommended operating current

### ● Maximum forward current – Ambient temperature

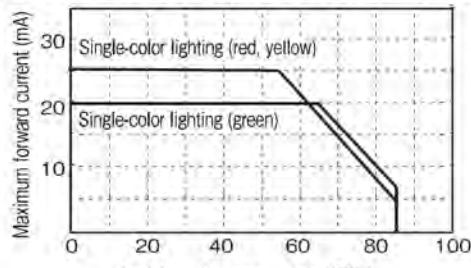

(Figure 8)

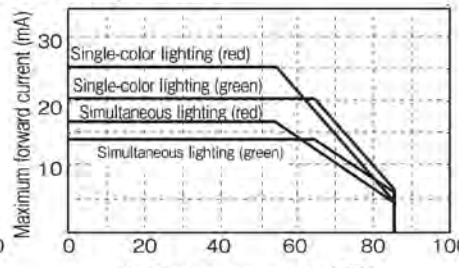

(Figure 9)

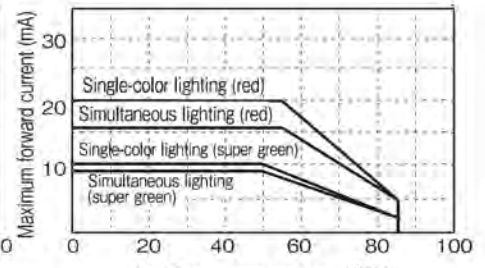

(Figure 10)

### ● Reference external resistor

Ta=25°C

Button size	Color	Mono-color (7) (8) (9)			Dual-color (78)		Dual-color (718)	
		Red	Green	Yellow	Red	Green	Red	Super green
15 square	5V	510Ω 1/16W	91Ω 1/16W	300Ω 1/16W	510Ω 1/16W	91Ω 1/16W	360Ω 1/16W	620Ω 1/16W
	12V	1.6kΩ 1/4W	820Ω 1/4W	1kΩ 1/4W	1.6kΩ 1/4W	820Ω 1/4W	1.2kΩ 1/4W	2.4kΩ 1/8W
	24V	3.6kΩ 1/2W	2kΩ 1/2W	2.2kΩ 1/2W	3.6kΩ 1/2W	2kΩ 1/2W	2.7kΩ 1/2W	5.6kΩ 1/4W
	Reference operating current(mA)	6	10	10	6	10	8	4
12 square	5V	620Ω 1/16W	270Ω 1/8W	330Ω 1/16W	620Ω 1/16W	270Ω 1/8W	510Ω 1/16W	910Ω 1/16W
	12V	2kΩ 1/8W	910Ω 1/4W	1.1kΩ 1/4W	2kΩ 1/8W	910Ω 1/4W	1.6kΩ 1/4W	3.6kΩ 1/16W
	24	4.3kΩ 1/4W	2kΩ 1/2W	2.4kΩ 1/2W	4.3kΩ 1/4W	2kΩ 1/2W	3.6kΩ 1/2W	8.2kΩ 1/8W
	Reference operating current(mA)	5	11	9	5	11	6	3
9 square	5V	910Ω 1/16W	390Ω 1/16W	470Ω 1/16W	910Ω 1/16W	390Ω 1/16W	750Ω 1/16W	1.2kΩ 1/16W
	12V	3kΩ 1/8W	1.3kΩ 1/4W	1.6kΩ 1/4W	3kΩ 1/8W	1.3kΩ 1/4W	2.4kΩ 1/8W	4.7kΩ 1/16W
	24V	6.8kΩ 1/4W	2.7kΩ 1/2W	3.6kΩ 1/2W	6.8kΩ 1/4W	2.7kΩ 1/2W	5.1kΩ 1/4W	11kΩ 1/8W
	Reference operating current(mA)	4	8	6	4	8	4	2

## Colour Plate Dimensions

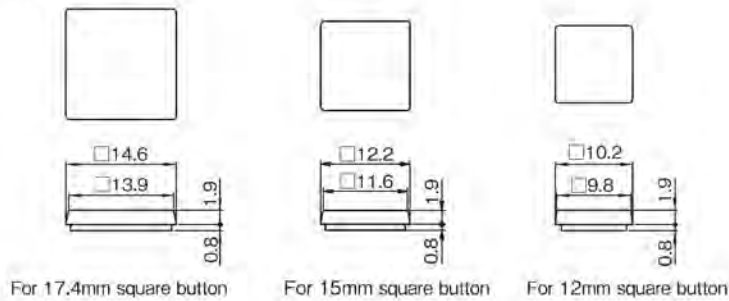

## Replacement Parts

Button size	Concave button	Raise dot button	Flat button	Color Plate
17.4mm square	KA-4590-1CC	KA-4590-2CC	—	KA-4591-LM
15mm square	KA-4768-1CC	KA-4768-2CC	KA-4769-1CC	KA-4770-LM
12mm square	KA-4603-1CC	KA-4603-2CC	KA-4730-1CC	KA-4604-LM
9mm square	—	—	K9-4707-LM	—

## Soldering Specifications

### \*Soldering

(1) Conduct preliminary testing for confirming the soldering conditions.

Switches could be deformed by heat depending on the , pattern and land on the PCB.

(2) The number of soldering is no more than twice, including corrective re-soldering.

When soldering repeatedly, wait at least five minutes between the first and second soldering until the work cools to room temperature.

Continuous heating can result in deformity of outer contours and deterioration.

### \*Recommended conditions for reflow soldering (when attaching single terminal)

Please set a reflow furnace referring to the temperature profile example shown below for the terminal temperature.

Deformity could result due to the heat if the product temperature exceeds 260°C, therefore ensure that the temperature on the product surface remains below 260°C.

Pre-heating : 150°C to 180°C  
60 to 120 sec  
Reflow : 220°C or above  
Within 30 to 60 sec  
Solder type : Sn 96.5  
Ag 3  
Cu 0.5  
\*A30C5 (JIS indication)

[Temperature profile example when lead-free solder is used]

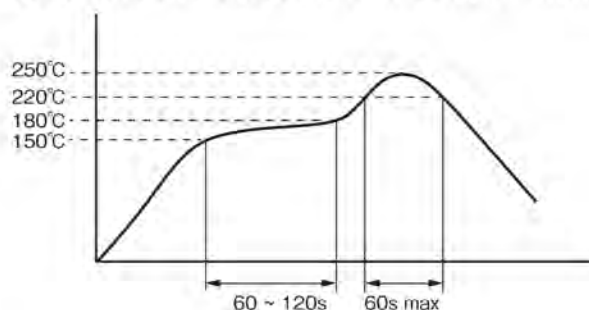

Speak to us direct about attaching parts continuously or in high density

### \*Manual soldering

(1) Soldering temperature: 350°C or less at tip of soldering iron.

(2) Soldering time: within 3 sec

### \*Cleaning

The switches are not washable.

Washing may cause flux and foreign matter on the PCB to get inside the switch along with cleaning fluid, and could cause failure.

### \*PCB

(1) We recommend confirming thickness of the PCB, pattern on the PCB and land prior to volume production.

These are affected for heat-resistant of switches.

(2) Handle the PCB carefully after attaching the switches.

The powder generated when dividing the PCB could get inside the switches.

Avoid piling assembled PCB.



## How to Order (KA)

### KA

#### LIGHT CARTRIDGE

KA-□□□□□□

#### ● BUTTON

12	12 square
15	15 square
17	17.4 square

#### ● BUTTON SHAPE

K	Concave button
P	Raise dot button
※ S	Flat button
※1) X	Without button

※Flat button is only 12 and 15 square type.

#### ● LED COLOR

78	Red and green
718	Red and super green
22	Multicolored
X	Without LED

#### ● OPERATIONAL FEEL ※2)

Blank	Without click feel
M	With click feel

#### ● COLOR PLATE

4	Milky white
※1) X	Without color plate

#### ● BUTTON COLOR

C	Clear
※1) X	Without button

#### HOUSING

KA□-KM

#### ● CIRCUIT CHARACTERISTIC AND OPERATIONAL FEEL ※2)

S	Momentary, without click feel
M	Momentary, with click feel

#### ● TERMINAL

M	Surface-mounted terminal
---	--------------------------

#### ● HOUSING COLOR

K	Black
---	-------

#### \*Caution

※1) In case of selecting without button(X), without color plate(X), please order button and color plate separately.

※2) If you request M (with click feel) for the operational feel of the housing, also specify M (with click feel) for the operational feel of the light cartridge.

In case you request S (without click feel) for the operation feel of the housing, specify blank for the operational feel of the light cartridge. Other combinations cannot be selected.

#### \*LED protection

For protecting LED, please apply suitable external current limiting resistors.

## How to Order (K9)

### K9

#### LIGHT CARTRIDGE

K9 - 9 [ ] [ ] [ ] X

● BUTTON

9	9 square
---	----------

● BUTTON SHAPE

S	Square flat
X	Without button

※1)

● LED COLOR

7	Red
8	Green
9	Yellow
78	Red and green
718	Red and super green
X	Without LED

● COLOR PLATE

X	Without color plate
---	---------------------

● BUTTON COLOR

M	Milky white
X	Without button

※1)

#### HOUSING

K9 [ ] - K M

● CIRCUIT CHARACTERISTIC AND OPERATIONAL FEEL ※2)

M	Momentary, with click feel
S	Momentary, without click feel

● TERMINAL

M	Surface-mounted terminal
---	--------------------------

● HOUSING COLOR

K	Black
---	-------

#### \*Caution

※1) In case of selecting without button(X), please order button separately.

※2) With or without click feel cannot be selected for the light cartridge. They can be selected for the housing only.

#### \*LED protection

For protecting LED, please apply suitable external current limiting resistors.



## Package Specifications

### KA

The Housing of KA-type switches is delivered in a tray. Tray specifications are as shown below.

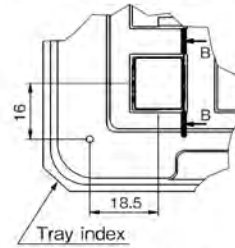
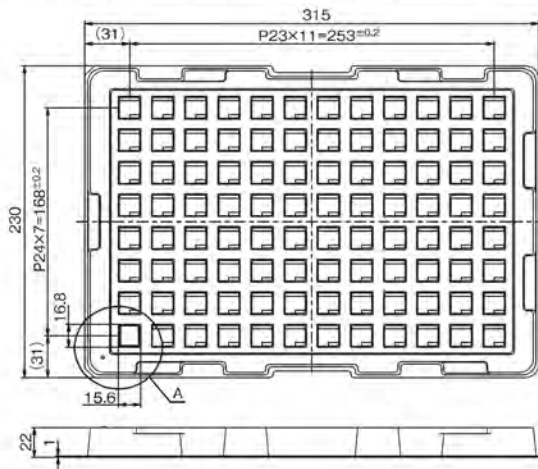

Section A details

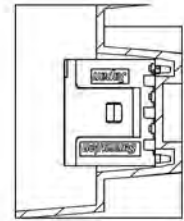

B-B cross-section

If ordered in 32 units or less, the order will be delivered in a product box. Trays, if needed, can be ordered by specifying the following product name and type.

Tray	Type	KA-4600
------	------	---------

The light cartridge is always delivered in a product box.

### K2, K9

The Housing of K2-type and K9-type switches is delivered in a tray. Tray specifications are as shown below.

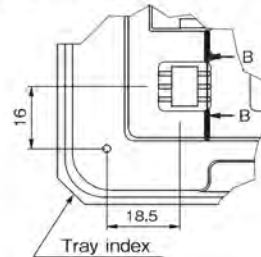
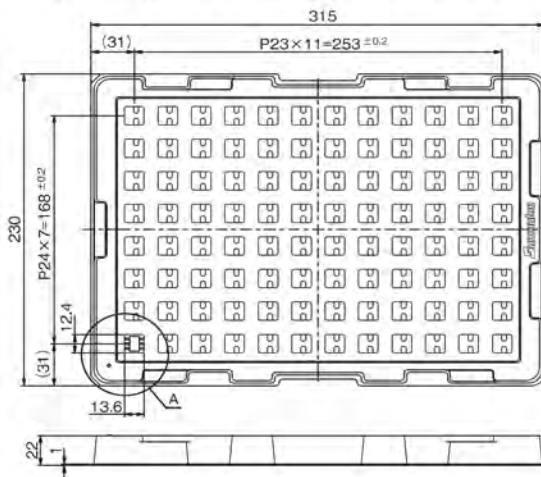

Section A details

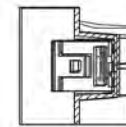

B-B cross-section

Trays, if needed, can be ordered by specifying the following product name and type.

Tray	Type	K2-4704
------	------	---------

The light cartridge is always delivered in a product box.

## Surface Mounting Process

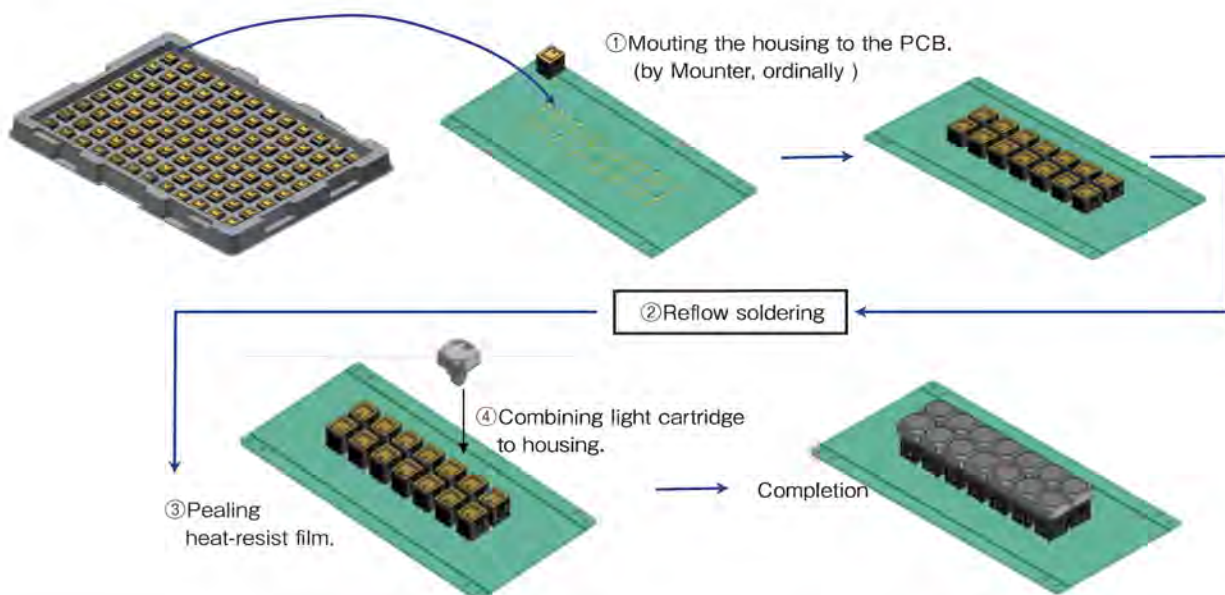

## Handling Instructions

### ● Mounting the KA light cartridge

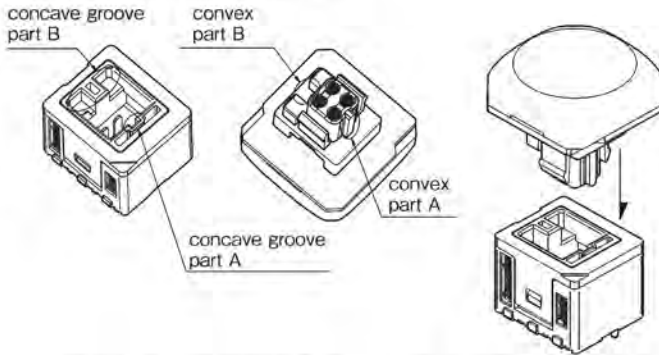

\* To combine the light cartridge with the housing, remove the seal attached to the housing. There is a proper direction for combining the light cartridge with the housing. As shown in the above diagram, insert the light cartridge by aligning the convex part A with concave groove part A, and convex part B with concave groove part B.

### ● Mounting the K2 light cartridge

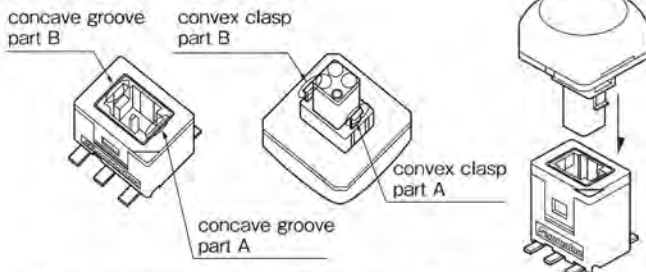

\* There is a proper direction for combining the light cartridge and housing. As shown in the above diagram, insert the light cartridge by aligning the convex clasp part A with concave groove part A, and convex clasp part B with concave groove part B.

### ● Mounting the K9 light cartridge

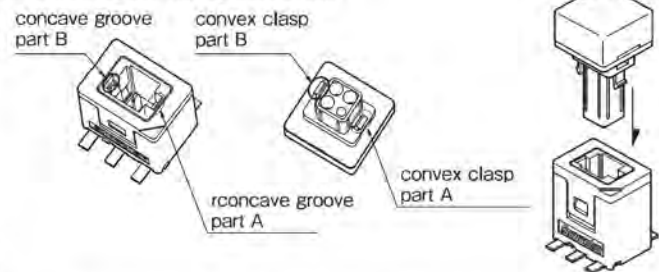

## Handling Precautions

### \*Handling of switches

#### (1) Usage environment

Prior to setting the product in the environment for actual usage, check that no corrosive or other gas is emitted from component parts in the vicinity. Avoid using in atmospheres containing sulfidizing gas (H<sub>2</sub>S, SO<sub>2</sub>), ammonia gas (NH<sub>3</sub>), nitrate gas (NH<sub>3</sub>), chlorine gas (CL<sub>2</sub>) or other corrosive gases, or under high temperature or humidity.

#### (2) Contact errors could result if silicon is present in the vicinity of the switch.

Remove the source of silicon if silicon oil, silicon filler, silicon wire or other silicon products are present around the switch.

#### (3) Dust-prevention measures

Avoid using the switches in places where dust is generated.

#### (4) Waterproofing and drip-proofing

The switches are not waterproof or drip-proof. Avoid installing or using them in places where they might be splashed with liquids.

#### (5) Automatic mounting

The switches can be mounted on PCB by mounter, but this may not be possible with some types of mounting machines. We recommend checking beforehand when using the product this way.

#### (6) Strength of terminals

Note that if a terminal is bent or twisted, its strength declines and the terminal could break.

### \*Notes on storage

#### (1) Storage environment

When storing the product, please take full consideration that the atmosphere, humidity and other storage conditions could affect the ease of soldering of terminals and packaging functions.

-Packaging material is expected to age more rapidly under high temperatures and humidity. We recommend storing the products indoors at temperatures up to 25°C and relative humidity up to 50%.

-Avoid storing the products in an environment with sulfidizing or other corrosive gases.

-Avoid direct sunlight and dust.

#### (2) Storage conditions

Store the products in the packaging.

Use products promptly after opening the packaging, and store the remaining products in an area free of gas, humidity and other factors which might affect performance.

Handle the products carefully to prevent damage to terminals from deforming.

### \*Character films

The character film is not included in the package. To use the character film, use a heat resistant film of 0.1mm thickness or less.

Please see the figure at right for dimensions.

17.4 mm square button

□13.9<sup>0.2</sup><sub>-0.2</sub>

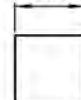

15mm square button

□11.6<sup>0.2</sup><sub>-0.2</sub>

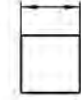

12mm square button

□9.8<sup>0.2</sup><sub>-0.2</sub>

