

SPECIFICATIONS

CONTACT RATING:

MECHANICAL LIFE: 30,000 make-and-break cycles.

CONTACT RESISTANCE: 10 mΩ max. initial @ 2-4VDC
100mA for both silver and gold plated contacts.

INSULATION RESISTANCE: 1,000 MΩ min.

DIELECTRIC STRENGTH: 1,000 Vrms min. @ sea level.

OPERATING TEMPERATURE: -30°C to 85°C.

MATERIALS

CASE: Diallyl phthalate (DAP) (UL94v-0).

HOUSING: Stainless Steel.

ACTUATOR: Nylon, black std.

CONTACT/TERMINALS: Copper alloy, with silver or gold plated.

TERMINAL SEAL: Epoxy.



HOW TO ORDER

MODEL NO. ACTUATOR ACTUATOR COLOR MOUNTING EARS TERMINATIONS TERMINAL PLATING SEAL RoHS SOLDERING

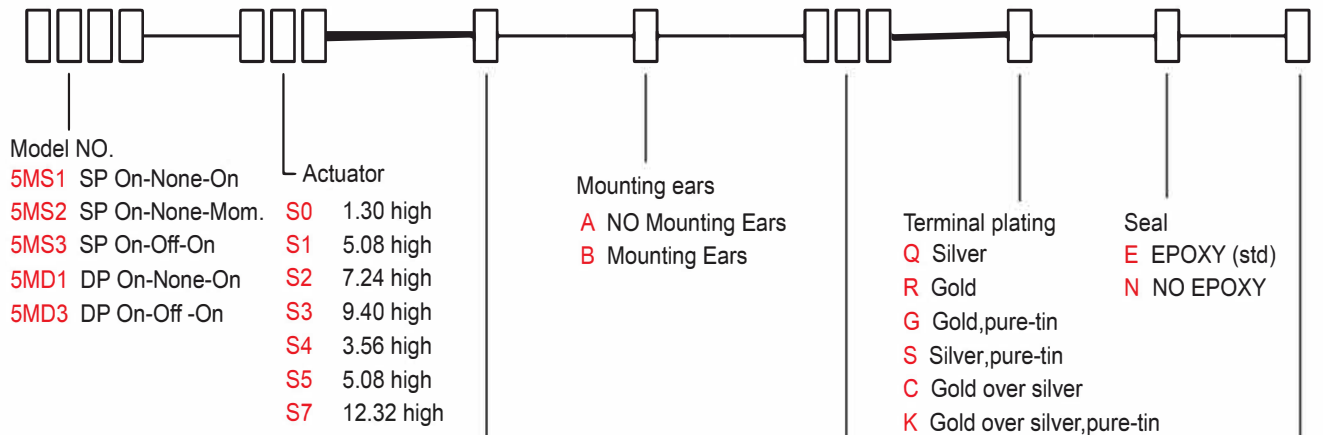

Actuator color

ITEM NO	COLOR
1	White
2	Black (Std)
3	Red
4	Orange
5	Yellow
6	Green
7	Blue
8	Brown
9	Gray

Terminations

M1 Solder Lug
M2 PC thru-hole
M3 Quick Connect
M51 18.70 high, wire wrap
M52 24.20 high, wire wrap
M53 10.55 high, wire wrap
M54 26.97 high, wire wrap
M6 Right angle, PC thru-hole
M7 Vertical right angle, PC thru-hole
VS2 V-bracket

RoHS soldering
 RoHS Compliant
 RoHS & Lead Free

* Besides standard color, other colors need to check stocks available.

SWITCH FUNCTION

NO. POLES	UL/CSA MODEL NO.	MODEL NO.	SWITCH FUNCTION			CONNECTED TERMINALS / SCHEMATIC		
			POS.1	POS.2	POS.3	POS.1	POS.2	POS.3
SP	Q1511	5MS1	ON	NONE	ON	2-1	N/A	2-3
	Q1512	5MS2	ON	NONE	MOM		OPEN	
	Q1513	5MS3	ON	OFF	ON			
DP	Q1521	5MD1	ON	NONE	ON	2-1,5-4	N/A	2-3,5-6
	Q1523	5MD3	ON	OFF	ON		OPEN	

MOM=MOMENTARY

POLE OPTIONS

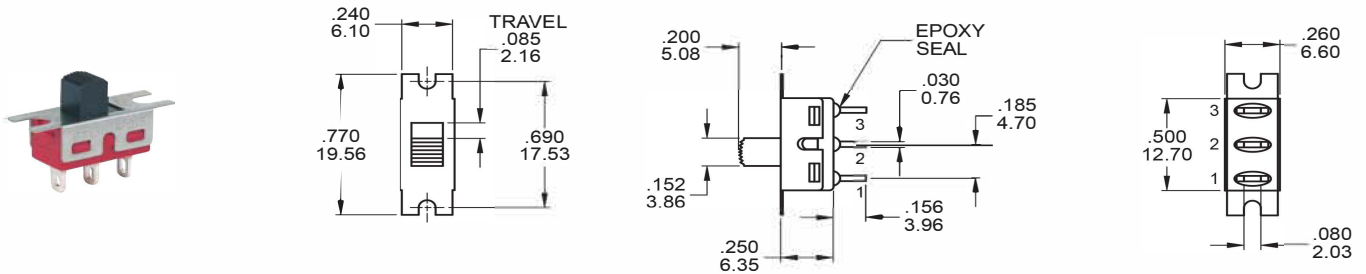

SPDT

Part No. Shown : 5MS1S102BM1QE

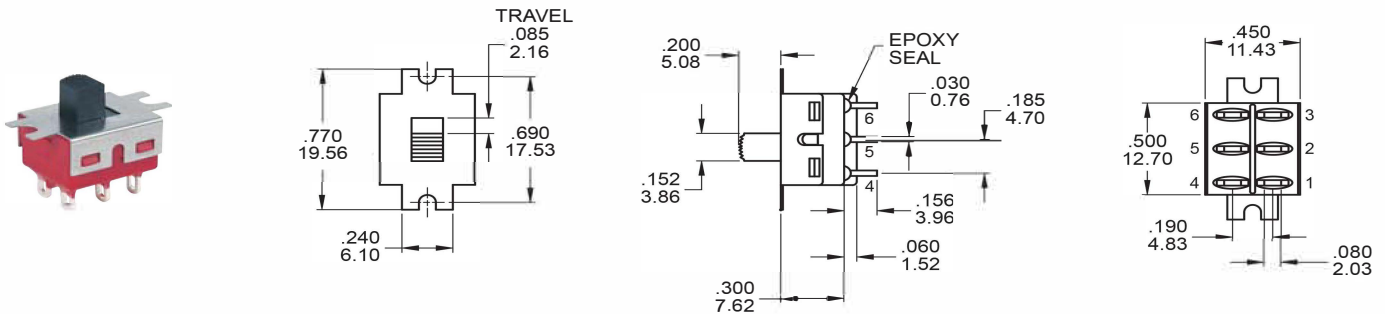

DPDT

Part No. Shown : 5MD1S102BM1QE

ACTUATOR OPTIONS

S1 STD

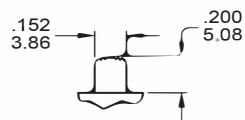

S2



S0

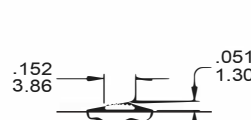

FRONT



For S0,S1,S2,S3,S4

▲ S5



FRONT

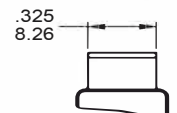

FOR DPDT ONLY

S3



S4



S7

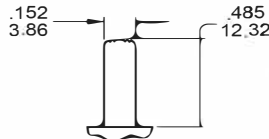

* Subtract .014(0.36) from Actuator height for M6, M7 P.C. MOUNTING OPTION.

TERMINATION OPTIONS

M1 Solder lug

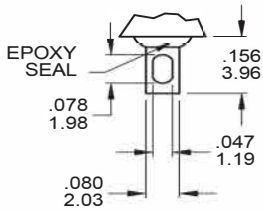

.030(0.76) THK.

M2 PC Thru-hole

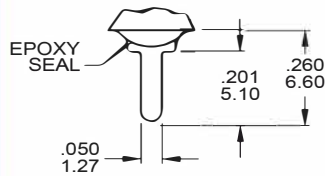

.030(0.76) THK.

M3 Quick connect

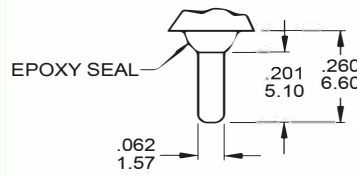

THK .030(0.76)

M5 Wire Wrap

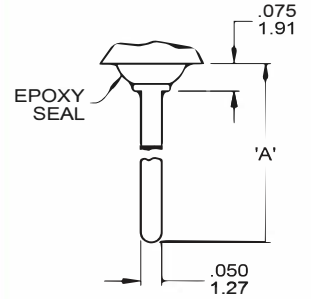

THK .030(0.76)

OTHER TERMINATION OPTIONS

M6 Right angle P.C. Mount

M7 Right angle P.C. Mount

VS2 Vertical bracket P.C. Mount

OPTION CODE	DIM. 'A'
M51	.736 (18.70)
M52	.953 (24.20)
M53	.415 (10.55)
M54	1.062 (26.97)

M6

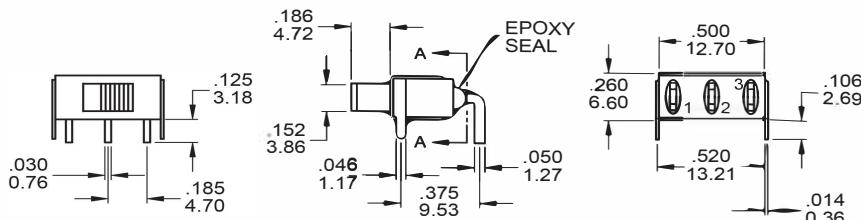

SECTION A-A
TERM.NOS.FOR
REFERENCE ONLY

P.C. MOUNTING

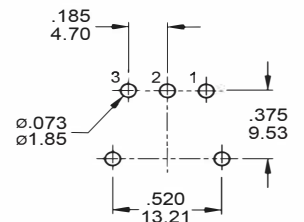

SPDT

Part No. Shown : 5MS1S102AM6QE

M6

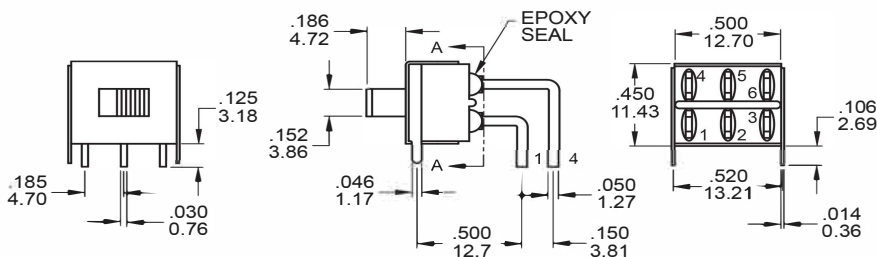

SECTION A-A
TERM.NOS.FOR
REFERENCE ONLY

P.C. MOUNTING

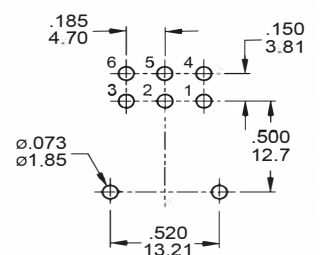

DPDT

Part No. Shown : 5MD1S102AM6QE

5M Series

M7

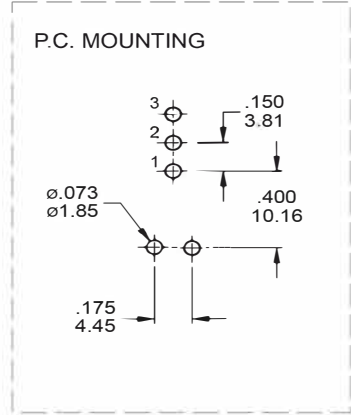
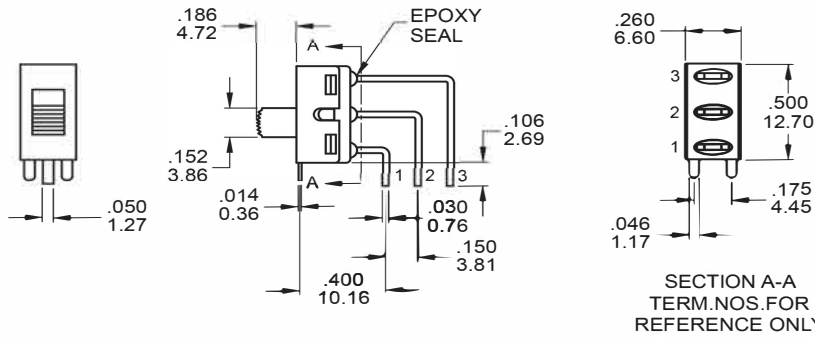

SPDT

Part No. Shown : 5MS1S102AM7QE

M7

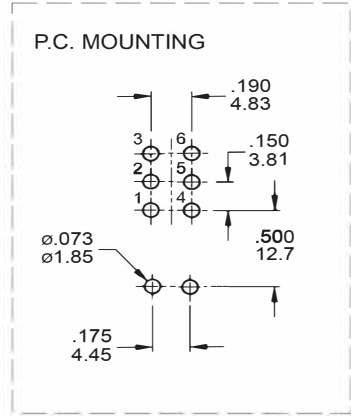
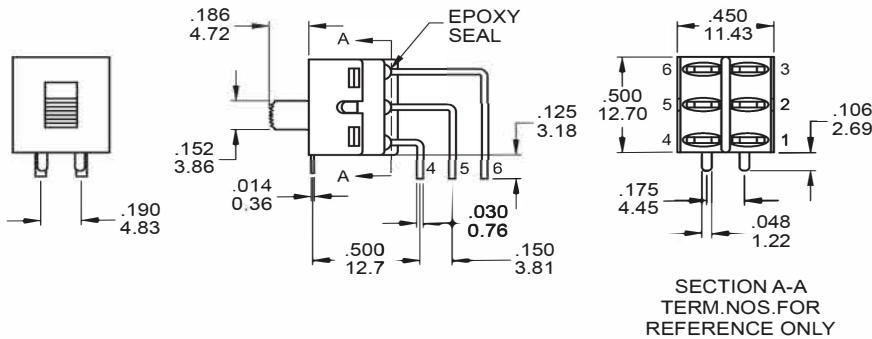

DPDT

Part No. Shown : 5MD1S102AM7RE

VS2

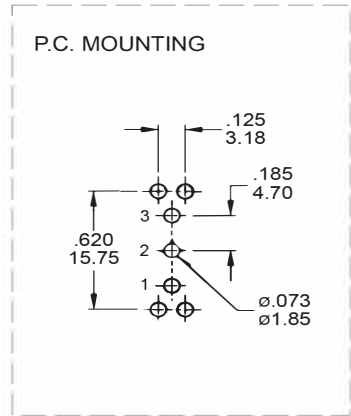
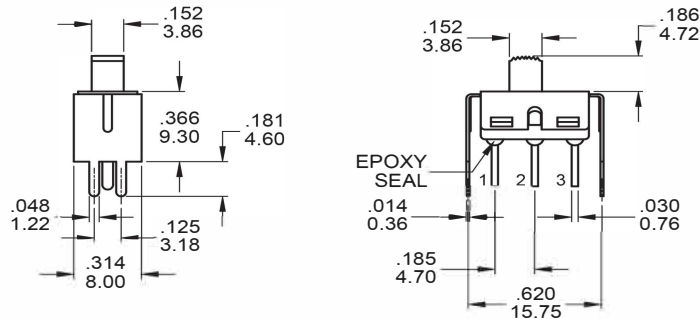
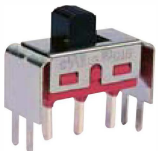

SPDT

Part No. Shown : 5MS1S102AVS2QE

VS2

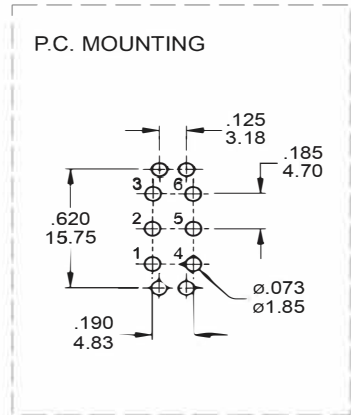
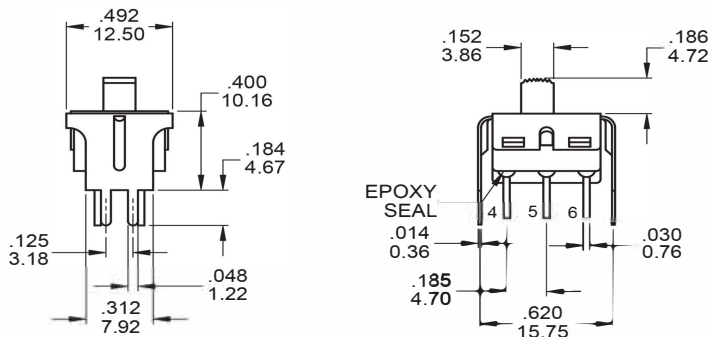
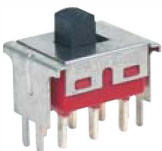

DPDT

Part No. Shown : 5MD1S102AVS2QE

MOUNTING EARS / PANEL MOUNT

MOUNTING EARS

"A" WITHOUT MOUNTING EARS

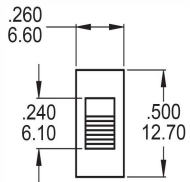

"B" WITH MOUNTING EARS

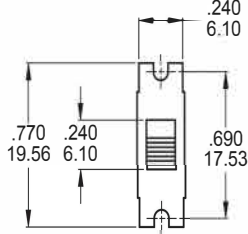

THREE POSITIONS ONLY

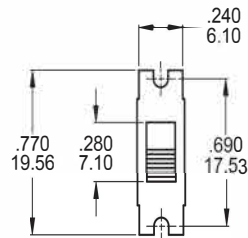
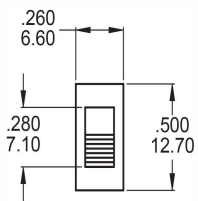

PANEL MOUNTING

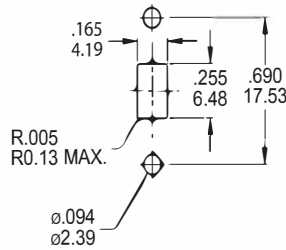

For S0,S1,S2,S3,S4

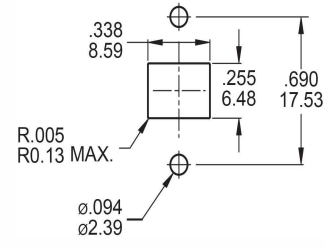

For S5 ONLY

THREE POSITIONS ONLY

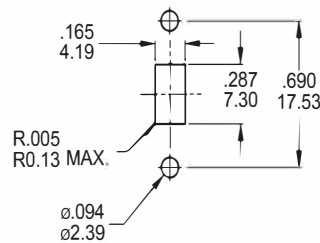

For S0,S1,S2,S3,S4

CONTACT MATERIAL OPTIONS

	CONTACT PLATING	TERMINAL PLATING	RATINGS
Q	Silver	Q = Silver	5 Amps with resistant load @ 120VAC or 28VDC 2 Amps with resistant load @ 250VAC
S		S = Silver,pure - tin	
C	Gold over Silver	C = Gold over silver	0.4 Volt - Amps (VA) max. @ 20V max. (AC or DC)
K		K = Gold over silver,pure - tin	
R	Gold	R = Gold	
G		G = Gold,pure - tin	

SOLDERING PROCESSES

MANUAL SOLDERING : Use soldering iron of 30 watts, controlled at 350°C approximately 5 seconds while applying solder.

WAVE SOLDERING : Recommended Soldering Temperature : 260 ± 5°C
Duration of Solder Immersion : Max 5sec. (PCB is 1.6mm in thickness)